

Varenummer: 203180M20100B2V

Beskrivelse: E+G Justerfod  
GN 31-80-M20-100-B2-V

Note: V Uden møtrik, udvendig sekskant i toppen, spændeflade i bunden

## Mål

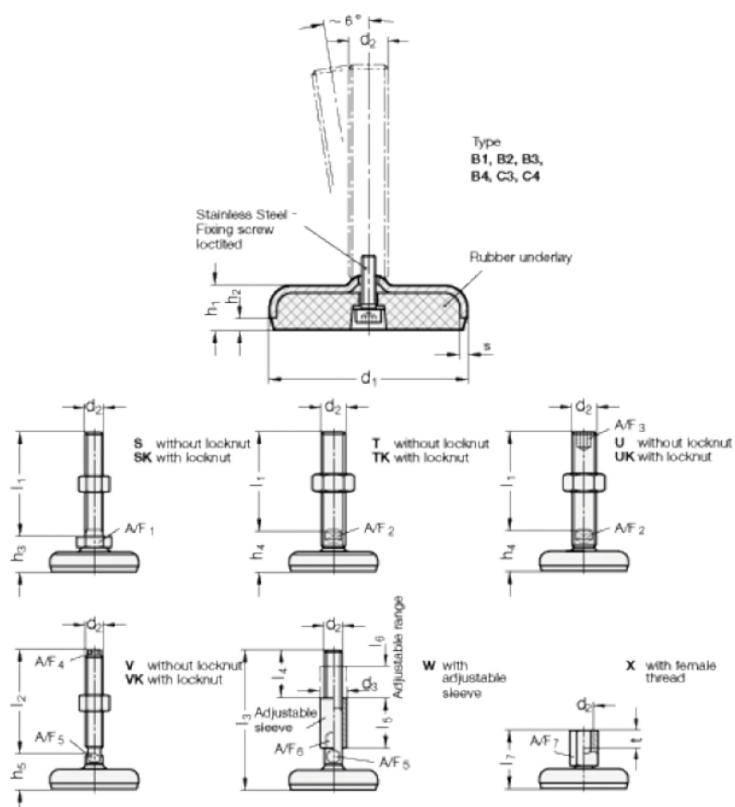

A/F4	= 13
A/F5	= 16
d1	= 80
d2	= 20
h1	= 18
h2	= 5
h5 +4.0/0	= 30
l2	= 100

s = 3